



SUMMA F SERIES

Professional flatbed
finishing systems



Summa.com | #SummaFinish

ABOUT SUMMA

Summa is a manufacturer of innovative cutting equipment that helps companies and people to finish their applications to the highest standards. Delivering outstanding quality conforming these high standards, has secured the Summa reputation for legendary performance.

Companies from all over the world use Summa cutting solutions for products in the printing, signage, display, apparel and packaging industry. With the cutting solutions from Summa your business is future-proof for many years to come.

Summa.com | [#SummaFinish](https://twitter.com/SummaFinish)



About Summa **02**

Summa F Series **04**

The Summa flatbed cutters are developed to grow with your business. Enjoy the countless possibilities all in one machine.

Base Unit **08**

Multiple flatbed sizes are available to fulfill your cutting needs.

Summa F1612 **09**

Summa F1432 **10**

Summa F1832 **11**

Summa F3220 **12**

Summa F3232 **13**

Modules & Tools **14**

The extensive range of modules and tools allow you to finish a wide variety of applications.

Tangential Module **16**

Drag Module **21**

Rotary Module **22**

Standard Router Module **23**

HF Router Module **24**

Tool Application Overview **25**

Media Handling & Workflows **28**

Rely on efficiency with media handling and optimised workflows.

Summa GoProduce Software **34**

Powerful, in-house developed software tailored to the Summa F Series.

Technical Specifications **39**

Order Codes **40**

SUMMA F SERIES, BUILT TO GROW WITH YOUR BUSINESS

With the F Series, Summa offers a future-proof cutting product line based on over 30 years of expertise in building the world's very best cutting plotters. These advanced engineered flatbed cutting tables are designed to cut various sheet and rigid materials as well as roll stock. A multi-functional cutting head, a great range of modules and tools and many media handling options contribute to the series' versatility and flexibility.

Over the years, the Summa F Series opened many doors for our customers, enabling them to expand business into new markets such as packaging design, Point Of Sale and textile applications.

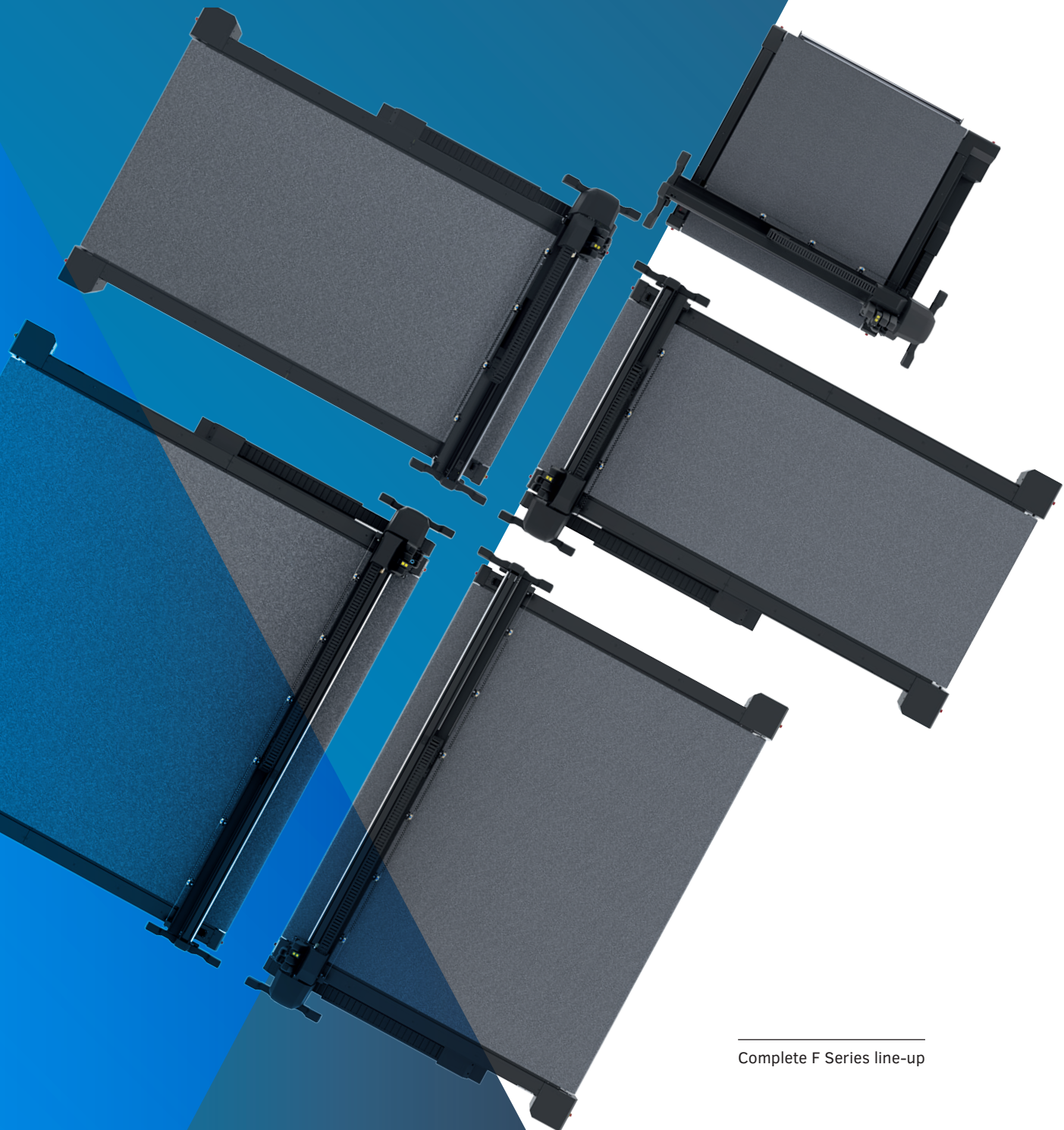

Complete F Series line-up

Applications

The F Series is designed to process a wide variety of materials for an even greater diversity of applications. Achieve a perfect cut with the Summa flatbed cutters to realise flawlessly finished end products.

S Sign & Display

The world of Sign and Display is broad and versatile. The flatbed cutting solutions can optimise your print & cut workflow, meet your customers' deadlines and deliver perfectly finished end-products.

- POS displays
- Soft signage
- Stickers
- Mock-up designs
- Traffic Signs
- Billboards

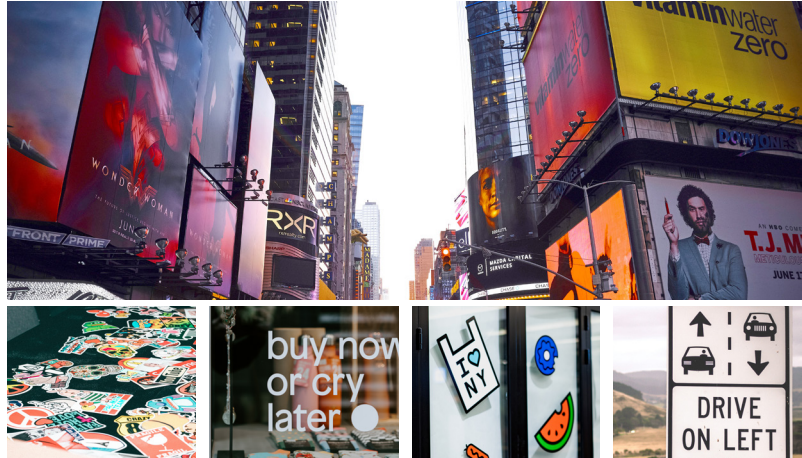

T Textile

When processing textiles, a most accurate cut is of key importance. With a great diversity in production processes, textile cutting is still often done manually. The flatbed cutters enable businesses to optimise their workflow, make it more efficient and significantly reduce material waste.

- Backlit displays
- Flags & banners
- Interior decoration
- Sportswear
- Fashion



P Packaging

In today's imaging dominated world the role of packaging is more relevant than ever. Packaging must, therefore, stand out and attract the eye of the beholder. At the same time, it is important packaging is strong enough to withstand transportation handling.

- Prototype packaging
- Customised packaging
- Short-run packaging
- Event-based packaging
- Creative packaging



SUMMA F SERIES

The F Series is developed to meet every customer's cutting need. For this reason, the flatbed cutters from Summa include so many elements to compose your ideal cutting solution.



F3220 w/ Heavy-Duty Roll Support

One Machine, Countless Possibilities

It starts with the base unit with a choice of no less than 5 models. Then you can carefully choose the modules and tools you need for your applications and consider the various media handling add-ons. Additionally, the included GoProduce software enables you to operate the cutter with ease and set up a productive workflow.

01 Base Unit

02 Modules & Tools

03 Media Handling Add-on

04 Software

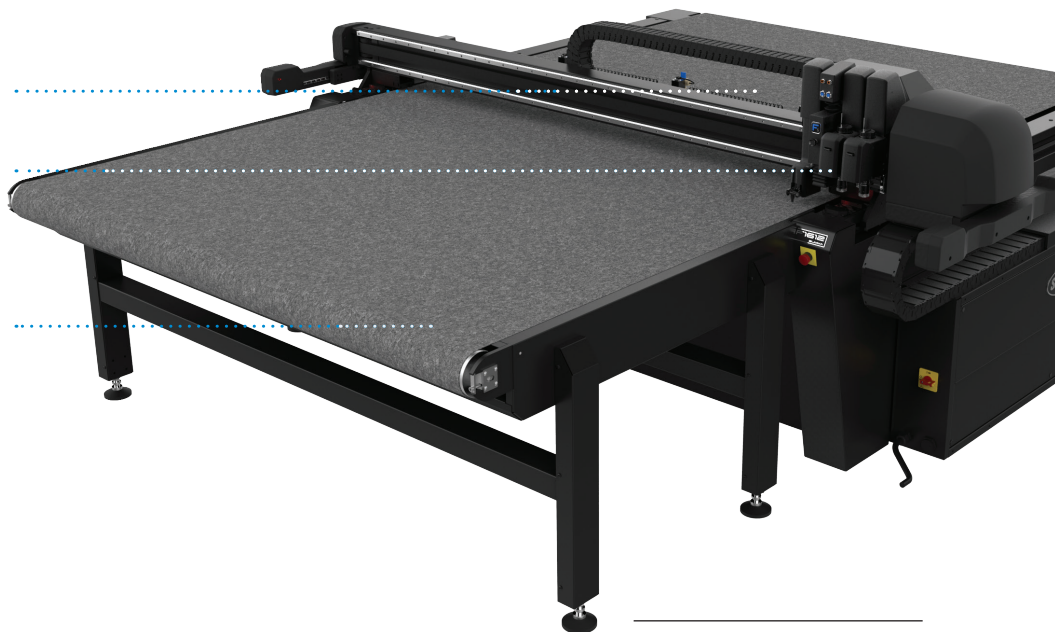

F1612 w/ Conveyor Extension

Build your workhorse

The Summa F Series include a number of very powerful elements to combine into your ideal cutting solution. What's more, the available tools are retrofittable and add-ons and media handling options can be acquired at any stage. This is exactly what makes an F Series flatbed cutter the ideal workhorse to grow with your business.

01 | Strong Base Unit

The base unit is the foundation of a good performing cutting workflow. It has to be strong and the right size. With Summa you can choose from no less than 5 models. Also, the integrated safety system is part of the flatbed's strong foundations contributing to a safe working environment. Summa products are CSA and ISO 9001 certified to meet the highest standards for efficiency, quality improvement and high-end service.

- Flatbeds available in five sizes
- Easy maintenance of the system
- Complies with worldwide health and safety requirements
- Highly advanced technology
- Cutting table remains easily accessible
- Optimised footprint
- CSA Certified
- ISO 9001 Certified

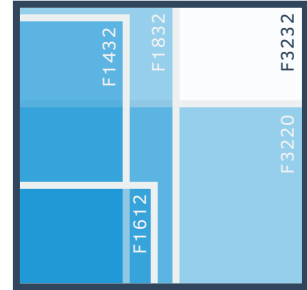

Working area comparison

02 | Extensive Range of Modules & Tools

The F Series perfectly grows in line with your business goals and aspirations. Open up to new markets and applications with the modules and tools of your choice. The multifunctional head is able to hold up to three modules at once, with the tools you prefer.

- Drag knife module
- Tangential module
- High Torque Rotary module
- Standard Router module
- High-Frequency Router module
- Extensive choice of tools



Tangential Module

03 | Efficient Media Handling & Workflows

The flatbed cutters are equipped with convenient media handling features and multiple add-ons to choose from. Further optimise your cutting workflow thanks to the operator zone, barcode workflow and F-Performance.

- Conveyor belt system
- Roll support system
- Vacuum table
- Media advance clamps
- Operator zone
- Poster trim
- Barcode workflow
- F-Performance
- And many more
- **Exclusive F1612 Add-ons:**
- Conveyor extension
- Basket
- Roll-up system
- Extension Tables

04 | Powerful Software

Summa GoProduce is a powerful and in-house developed software. The cornerstone of the good functioning of your F Series. Tailor and use the software as you wish through targeted features and choose the level of advancement according to your specific cutting requirements.

- Material manager
- Custom configuration of action sets
- Barcode functionality (Pro Pack)



Summa GoProduce

A STRONG BASE TO BUILD UPON

High-quality cutting equipment relies on a strong base. It requires a cutting unit which can be enhanced with additional features, options and add-ons at any given time. This way, the cutter can grow together with your business goals and aspirations. That is what the F Series is all about. Providing a solid base to transform your F Series model into the versatile cutting solution that perfectly fits your business needs.

The F Series is your versatile business companion.
A companion you can build upon.



TIP | The following product sheet pages can be used or printed separately for your reference.

F1612 w/two Tangential Modules

SUMMA F1612

The F1612 is Summa's smallest F Series flatbed cutter, fitting effortlessly into many production area's. It represents the ideal cutting solution for sign makers who want to automate their cutting workflow or extend their cutting applications.

Key Benefits

- Small footprint
- Straightforward installation
- Media handling options
- Modular tooling system
- Integrated Safety System
- Future-proof

Ideal to cut:

- Cardboard material
- Roll stock
- (Technical) textile
- Synthetic material
- Foamboard
- Wood



Legendary Performance



Summa website

| | |
|------------------------------------|---|
| Model | F1612 |
| Dimensions | 247 x 220 x 110 cm |
| Material width | Up to 165 cm |
| Work zone | 160 x 120 cm |
| Vacuum | 1.3 kW (50Hz) / 1.75 kW (60Hz) |
| Vacuum zones | Variable on the width of the machine |
| Requirements | Standard: 3 x 400V + N, 50Hz, max 20A Or: 3 x 208V + N, 60Hz, max 30A Or: 3 x 230V, 50Hz, max 20A |
| Standard solution includes: | <ul style="list-style-type: none"> • F Series flatbed system • Conveyor system with pneumatic media clamps and roll support • Security Pack • Camera system • Axis Control software • Drag module • ADC left & right • GoProduce software • Speed: up to 1000 mm/sec • Acceleration: up to 1G |

Modules & Tools

All F Series models can be equipped and retrofitted with various modules and tools. This makes the F Series ideal to grow with your business and open up new markets at any given time.

- High-Frequency Router
- High Torque Rotary module
- Tangential module
- V-Cut tools, Creasing tools, Heavy-Duty Cutout tool, etc.

Media Handling & Workflows

The flatbed cutter is standard equipped with a range of convenient media handling features. For the F 1612 model special media handling options are available to further enhance the use of this compact flatbed.

Enjoy an automated workflow and ease-of-use:

- Twin Workflow
- Operator Zone
- Poster Trim
- Barcode Workflow

Media Handling Add-Ons

- Conveyor extension
- Roll-up system
- Extension tables
- Basket



SUMMA F1432

The F1432 is the latest addition to the F Series flatbed cutters. It allows to process popular 137 cm/54" roll widths more efficiently and its working length gives sufficient margin to easily cut 3m/10ft jobs. For many businesses, this size is the ideal interim solution between the F1612 and F1832 models.

Key Benefits

- Perfect interim size
- Modular tooling system
- Integrated Safety System
- Future-proof

Ideal to cut:

- Roll stock
- Lengthy materials
- Cardboard material
- (Technical) textile
- Synthetic material

Modules & Tools

All F Series models can be equipped and retrofitted with various modules and tools. This makes the F Series ideal to grow with your business and open up new markets at any given time.

- High Frequency Router
- High Torque Rotary module
- Tangential module
- V-Cut tools, creasing tools, Heavy-Duty Cutout tool, etc.

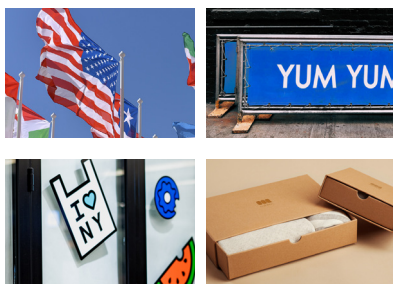

Legendary Performance



Summa website

| | |
|------------------------------------|---|
| Model | F1432 |
| Dimensions | 230 x 422 x 122 cm |
| Material width | Up to 142 cm |
| Work zone | 136 x 320 cm |
| Vacuum | 2.2 kW (50Hz) / 2.55 kW (60Hz) |
| Vacuum zones | 6 zones (2 lines x 3 columns) |
| Requirements | Standard: 3 x 400V + N, 50Hz, max 30A Or: 3 x 208V + N, 60Hz, max 30A Or: 3 x 230V, 50Hz, max 20A |
| Standard solution includes: | <ul style="list-style-type: none"> • F Series flatbed system • Conveyor system with pneumatic media clamps and roll support • Security Pack • Camera system • Axis Control software • Drag module • ADC left & right • GoProduce software • Speed: up to 1000 mm/sec • Acceleration: up to 1G |

Media Handling & Workflows

The flatbed cutter is standard equipped with a range of convenient media handling features. Enjoy an automated workflow and ease-of-use:

- Twin Workflow
- Operator Zone
- Poster Trim
- Barcode Workflow
- Tandem Mode



SUMMA F1832

The F1832 F Series flatbed cutter is a perfect match for cutting popular materials, such as 150 cm wide rolls and 152 x 304 cm rigid board materials. Combined with the High Torque rotary tool, the F1832 is ready to conquer also the textile market with the ability to cut the popular textile size of 183 cm.

Key Benefits

- Processes popular board and roll material
- Modular tooling system
- Integrated Safety System
- Future-proof

Ideal to cut:

- Cardboard material
- Roll stock
- (Technical) textile
- Synthetic material
- Foamboard
- Wood

Modules & Tools

All F Series models can be equipped and retrofitted with various modules and tools. This makes the F Series ideal to grow with your business and open up new markets at any given time.

- High Frequency Router
- High Torque Rotary module
- Tangential module
- V-Cut tools, creasing tools, Heavy-Duty Cutout tool, etc.



Legendary Performance



Summa
website

| | |
|------------------------------------|---|
| Model | F1832 |
| Dimensions | 279 x 422 x 122 cm |
| Material width | Up to 190 cm |
| Work zone | 184 x 320 cm |
| Vacuum | 2 x 2.2 kW (50Hz) / 2 x 2.55 kW (60Hz) |
| Vacuum zones | 8 zones (2 lines x 4 columns) |
| Requirements | Standard: 3 x 400V + N, 50Hz, max 30A Or: 3 x 208V + N, 60Hz, max 30A Or: 3 x 230V, 50Hz, max 20A |
| Standard solution includes: | <ul style="list-style-type: none"> • F Series flatbed system • Conveyor system with pneumatic media clamps and roll support • Security Pack • Camera system • Axis Control software • Drag module • ADC left & right • GoProduce software • Speed: up to 1000 mm/sec • Acceleration: up to 1G |

Media Handling & Workflows

The flatbed cutter is standard equipped with a range of convenient media handling features. Enjoy an automated workflow and ease-of-use:

- Twin Workflow
- Operator Zone
- Poster Trim
- Barcode Workflow
- Tandem Mode

Media Handling Add-on Available:

- Heavy-Duty Roll Support



SUMMA F3220

The F3220 F Series flatbed cutter has a working width of 3.2 m. It is the ideal companion to process wide-format materials with utmost ease and accuracy. Thanks to the size users are able to obtain a print & cut workflow fitting seamlessly into each other, opening up to endless applications for the textile market in particular.

Key Benefits

- Matches 3.2 m wide textile printers
- Ideal for high-production environments
- HD RS for heavy roll material
- Modular tooling system
- Integrated Safety System
- Future-proof

Ideal to cut:

- Textile (flags, mesh, banners)
- 3 m x 2 m board material

Modules & Tools

All F Series models can be equipped and retrofitted with various modules and tools. This makes the F Series ideal to grow with your business and open up new markets at any given time.

- High Frequency Router
- High Torque Rotary module
- Tangential module
- V-Cut tools, creasing tools, Heavy-Duty Cutout tool, etc.

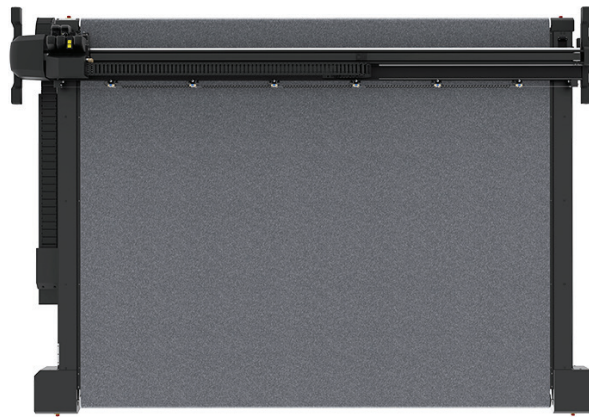

Legendary Performance



Summa website

| | |
|------------------------------------|---|
| Model | F3220 |
| Dimensions | 422 x 313 x 122 cm |
| Material width | Up to 332 cm |
| Work zone | 327 x 210 cm |
| Vacuum | 4 kW (50Hz) / 4.6 kW (60Hz) |
| Vacuum zones | 7 zones (1 lines x 7 columns) |
| Requirements | Standard: 3 x 400V + N, 50Hz, max 20A Or: 3 x 208V + N, 60Hz, max 30A Or: 3 x 230V, 50Hz, max 20A |
| Standard solution includes: | <ul style="list-style-type: none"> • F Series flatbed system • Conveyor system with pneumatic media clamps and roll support • Security Pack • Camera system • Axis Control software • Drag module • ADC left & right • GoProduce software • Speed: up to 1000 mm/sec • Acceleration: up to 1G |

Media Handling & Workflows

The flatbed cutter is standard equipped with a range of convenient media handling features. Enjoy an automated workflow and ease-of-use:

- Twin Workflow
- Operator Zone
- Poster Trim
- Barcode Workflow

Media Handling Add-On Available:

- Heavy-Duty Roll Support



SUMMA F3232

The F3232 is Summa's large-format F Series flatbed cutter, the ideal companion to process popular print sizes with utmost ease and accuracy. The large working area enables a print & cut workflow fitting seamlessly into each other, opening up to endless applications for sign&display and textile market.

Key Benefits

- Matches 3.2 m wide textile printers
- Ideal for high-production environments
- HD RS for heavy roll material
- Modular tooling system
- Integrated Safety System
- Future-proof

Ideal to cut:

- Textile (flags, mesh, banners)
- 3 m x 2 m board material

Modules & Tools

All F Series models can be equipped and retrofitted with various modules and tools. This makes the F Series ideal to grow with your business and open up new markets at any given time.

- High Frequency Router
- High Torque Rotary module
- Tangential module
- V-Cut tools, creasing tools, Heavy-Duty Cutout tool, etc.

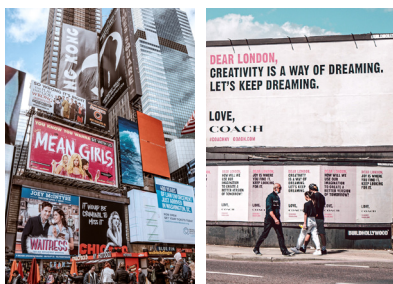

Legendary Performance



Summa website

| | |
|------------------------------------|---|
| Model | F3232 |
| Dimensions | 422 x 422 x 122 cm |
| Material width | Up to 332 cm |
| Work zone | 327 x 320 cm |
| Vacuum | 2 x 2.2 kW (50Hz) / 2 x 2.55 kW (60Hz) |
| Vacuum zones | 14 zones (2 lines x 7 columns) |
| Requirements | <p>Standard: 3 x 400V + N, 50Hz, max 20A</p> <p>Or: 3 x 208V + N, 60Hz, max 30A</p> <p>Or: 3 x 230V, 50Hz, max 20A</p> |
| Standard solution includes: | <ul style="list-style-type: none"> • F Series flatbed system • Conveyor system with pneumatic media clamps and roll support • Security Pack • Camera system • Axis Control software • Drag module • ADC left & right • GoProduce software • Speed: up to 1000 mm/sec • Acceleration: up to 1G |

Media Handling & Workflows

The flatbed cutter is standard equipped with a range of convenient media handling features. Enjoy an automated workflow and ease-of-use:

- Twin Workflow
- Operator Zone
- Tandem Mode
- Poster Trim
- Barcode Workflow

Media Handling Add-On Available:

- Heavy-Duty Roll Support



MODULES & TOOLS

The F Series models are equipped with a **multi-functional cutting head** that is able to hold up to three cutting modules at once. The system is therefore able to efficiently process cutting jobs including multiple cutting techniques. Or to quickly switch between jobs in which different materials are used. The LED pointer in the central unit and integrated camera system enable fast and accurate mark recognition.

SLOT 1
Drag module

SLOT 2
Tangential module

SLOT 3
Tangential module



Extensive range of Modules & Tools

Summa offers an extensive range of modules and tools to choose from. Choose what cutting modules you need based on the products you produce or will produce in the future. Start with the basics or discover the more advanced options with the Tangential cutting module.

Tangential Module for:

- Adhesive vinyl
- Window film
- Magnetic material
- Reflective sheeting
- Foamboard with paper
- Adhesive PVC banner vinyl
- Cardboard
- Polypropelene
- Polycarbonate
- Sandblast material



Tangential Module

Router Module for:

- Corrugated PP board
- Expanded PVC board
- Polycarbonate
- ACP/ACM
- MDF
- Foamcore with HIPS liner
- Plexi



Router Module

Rotary Module for:

- Uncoated woven polyester
- Coated woven polyester
- Packaging foam
- Synthetic textiles
- Technical textiles



High Frequency Rotary Module

Drag Module for:

- Paper
- Adhesive vinyl
- Adhesive PVC Banner Vinyl



Drag Module

Knives, Blades & Bits

Each of the above modules can house different tools, blades and bits. Choose the tool you need to cut your specific material and obtain the best cutting quality. All tools include a barcode ID, ensuring automatic recognition and parameter pre-sets.

You can extend your tool gamut whenever you see fit as your company grows.

Automated Depth Control | ADC

The Automated Depth Control (ADC) simplifies tool, knife or bit changes significantly. The ADC measures the tip of the knife or bit accurately and sets the down position of the tool to the table's level, thus guaranteeing a flawless cut.

Benefits

- Easy tool change
- Automatic depth measuring
- Flawless cutting
- Less operator intervention
- Saving valuable time

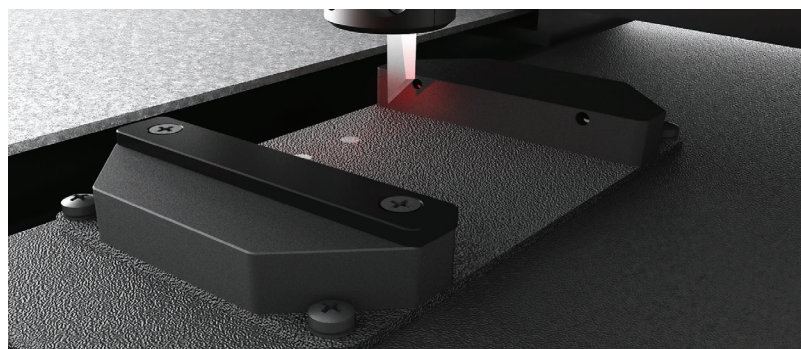

Video: ADC



TANGENTIAL MODULE

The powerful Tangential Module offers a vertical force of 10 kg and corresponds to a wide range of matching tools enabling users to process an abundance of applications. Each of the many and varied tools has a barcode ID, which ensures automatic recognition and parameter settings.

Thanks to the multi-functional head on the F Series, users are able to install up to three modules. This way, multiple jobs with different cutting techniques can be assigned to a single machine, such as creasing and cutting, without the need to remove modules.



The wide range of tools is yours to choose from



Kiss-Cut Tool

- Clean cuts for easy weeding

Single Edge Cutout Tool

- Cuts materials up to 6 mm thick

Double Edge Cutout Tool

- Ideal to cut rigid material

Heavy-Duty Cutout Tool

- Cuts material up to 15 mm thick

Creasing Tools

- Clean creases without tearing

V-Cut Tools

- Precise angle adjustments

Perforating Tool **NEW**

- Efficient and fast perforations

Electronic Oscillating Tool

- High processing speeds

Pneumatic Oscillating Tool

- High-performance cutting tool

Pneumatic Oscillating Tool-L

- Thick and soft materials

Kiss-Cut Tool



With mechanically-controlled knife pressure, this tool is specifically designed for kiss-cutting material down to its liner up to 1.2 mm thick. This tool also includes an adjustable nose piece for precise depth control.

Strongest features

- Precise depth control
- Clean cuts for easy weeding
- Cuts a wide variety of vinyl and film

Ideal for cutting:

- Paper < 200g
- Adhesive vinyl
- Sandblast material
- Window film
- Magnetic material
- Adhesive PVC Banner material

Blades



390-534 - Tangential Knife 36°
Max cutting thickness - 0.25 mm



390-550 - Tangential Knife 60°
Max cutting thickness - 1.2 mm

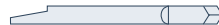

390-551 - Tangential Double Tip Knife 36°
Max cutting thickness - 0.25 mm



390-560 - Tangential Knife 45° wedge 40/25°
Max cutting thickness - 1 mm



Single Edge Cutout Tool



The Single Edge Cutout Tool is designed for detailed cutting through materials up to 6 mm thick. A spring-loaded gliding disk allows cutting of very precise details and can be fixed at a set depth.

Strongest features

- Precise cutting of details
- Cuts material up to 6 mm thick
- Fixed depth setting

Ideal for cutting:

- Paper < 200 gr
- Cardboard 300-500 gr
- Adhesive vinyl
- Foamboard <= 2 mm
- Polypropylene <= 1.2 mm
- Polycarbonate <= 0.6 mm
- Adhesive PVC
- Magnetic material

Blades



500-9801 - Single Edge Cutout Knife 65°
Max cutting thickness (with gliding disk) - 6 mm
Max cutting thickness (without gliding disk) - 6 mm



Double Edge Cutout Tool



The Double Edge Cutout Tool ensures minimal wear when cutting through rigid material up to 5 mm thick. Here also, a spring-loaded gliding disk allows cutting of very precise details and can be fixed at a set depth.

Strongest features

- Precise cutting of details
- Cuts at both knife sides
- Minimal knife wear
- Ideal to cut rigid material

Ideal for cutting:

- Paper < 200 gr
- Cardboard 300-500 gr
- Adhesive vinyl
- Adhesive PVC
- PVC Banner
- Reflective sheeting
- Expanded PVC board <= 1.2 mm
- Polypropelene <= 1.2 mm
- Polycarbonate <= 0.6 mm
- Magnetic material

Blades



500-9802 - Double Edge Cutout Knife 50°
Max cutting thickness (with gliding disk) - 3 mm
Max cutting thickness (without gliding disk) - 3 mm



500-9803 - Double Edge Cutout Knife 60°
Max cutting thickness (with gliding disk) - 5 mm
Max cutting thickness (without gliding disk) - 5 mm



500-9804 - Double Edge Cutout Knife 50° Burr-Free
Max cutting thickness (with gliding disk) - 3 mm
Max cutting thickness (without gliding disk) - 3 mm



Heavy-Duty Cutout Tool



The Heavy-Duty Cutout Tool is suitable for cutting through thicker materials up to 15 mm thick.

Strongest features

- Ideal to cut very thick material

Ideal for cutting:

- Cardboard 300-500 gr
- Adhesive vinyl
- Adhesive PVC
- PVC Banner
- Corrugated PP board <= 5 mm
- Expanded PVC board <= 1.2 mm
- Polypropelene <= 1.2 mm
- Polycarbonate <= 0.6 mm
- Foamcore with paper liner <= 5 mm
- Varnish blankets

Blades



500-9807 - Heavy-Duty Cutout Knife 45° - 90°
Max cutting thickness - 15 mm



Creasing Tools

Several creasing wheels, designed in different depths and radius sizes, are available for creasing and scoring paper, cartons, polypropylene and PVC material.

Strongest features

- Clean creases without tearing
- Directional pressure adjustments

Ideal for creasing:

- Corrugated B-C-A-EE-BC flute (3 - 6 mm)
- Corrugated C Flute (4 mm)
- Corrugated E Flute (1.5 mm)
- Paper < 200gr
- Cardboard 300 - 500 gr m2
- Polypropylene sheets <= 1.2 mm
- Corrugated B-C-A-EE-BC flute (3-6mm)

Line up creasing tools

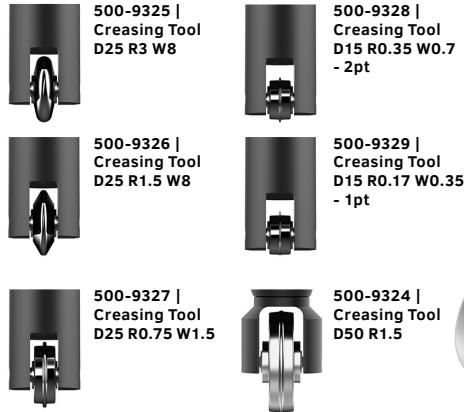

Video:
Creasing
Tool D50



V-Cut Tools

The V-Cut Tools are available in 5 angles and are designed to cut a V-shaped groove in rigid sandwich and foam composite boards up to 27 mm thick, depending on the material's density.

Strongest features

- Precise angle adjustment
- Very fast blade changes

Ideal for cutting:

- Honeycomb board
- Foamcore with paper liner

Blades



500-9825 - V-Cut Blade 0.9 mm
Max cutting thickness 18-27 mm



500-9826 - V-Cut Hard Metal
Max cutting thickness 18-27 mm

Line up V-Cut tools

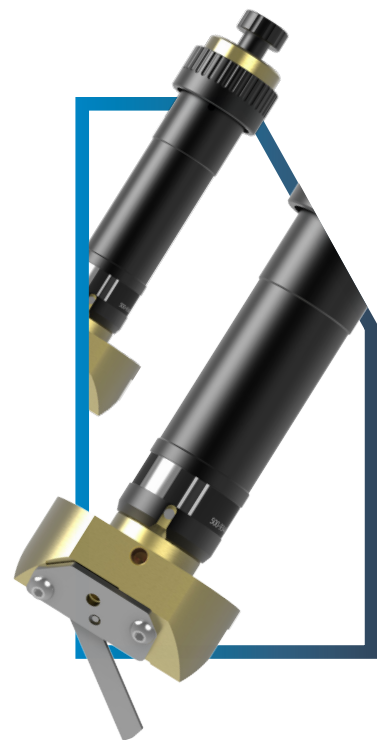

Perforating Tool **NEW**



The new Summa perforating tool for the F Series is used to make perforations in a very efficient and fast way. By using this tool, the perforated materials will be a lot easier to bend or fold. Then, the folds will have sharper 90° edges resulting in a nicer finish. This will save considerable time in the assembling of, for instance, cardboard or polypropylene boxes.

Strongest features

- Up to 25 times faster cutting of perforation lines (versus EOT tool)
- Alternative for creasing. Folding and bending lines into cardboard
- High-quality perforated cuts
- Several knives available

Ideal for cutting:

- Solid cardboard
- Corrugated board
- Polypropylene film

Knives

500-9890 |
Perforation Knife
1 x 1 mm
D 1.1 mm

500-9892 |
Perforation Knife
3 x 3 mm D 4 mm

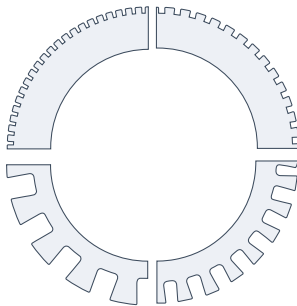

500-9891 |
Perforation Knife
1.7 x 1.7 mm
D 1.1 mm

500-9893 |
Perforation Knife
5 x 5 mm
D 4 mm



Electronic Oscillating Tool | EOT



Ideal for cutting soft and medium density materials such as corrugated board and foam up to 18 mm thick. The Electronic Oscillating Tool is driven by an electric motor, producing up to 12,000 rpm and moves a knife up and down over a stroke of 1 mm.

Strongest features

- Powerful cutting tool
- High processing speeds
- Low maintenance

Ideal for cutting:

- Corrugated B-C-E Flute (1.5-4 mm)
- Foamcore with paper liner <= 10 mm
- Foamcore with paper liner > 5 mm
- Honeycomb board < 10 mm
- Gasket



500-9815 -EOT L33 Knife 45° - 85°
Max cutting thickness (with gliding disk) - 13 mm
Max cutting thickness (without gliding disk) - 19 mm



500-9814 -EOT L38 Knife 45° - 86°
Max cutting thickness (with gliding disk) - 18 mm
Max cutting thickness (without gliding disk) - 24 mm

Blades

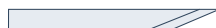

500-9800 - EOT L25 Knife 65°
Max cutting thickness (with gliding disk) - 5 mm
Max cutting thickness (without gliding disk) - 5 mm



500-9810 - EOT L25 Knife 65° - 80°
Max cutting thickness (with gliding disk) - 5 mm
Max cutting thickness (without gliding disk) - 11 mm



500-9811 - EOT L25 Knife 65° - 85°
Max cutting thickness (with gliding disk) - 5 mm
Max cutting thickness (without gliding disk) - 11 mm



500-9813 - EOT L25 Knife 0° - 75°
Max cutting thickness (with gliding disk) - 5 mm
Max cutting thickness (without gliding disk) - 6 mm



500-9812 - EOT L28 Knife 65° - 85°
Max cutting thickness (with gliding disk) - 8 mm
Max cutting thickness (without gliding disk) - 14 mm



Pneumatic Oscillating Tool | POT



The standard Pneumatic Oscillating Tool, powered by compressed air, moves its knife up and down over a stroke of 8 mm. The robust construction of the tool makes it suitable to cut thick material, such as honeycomb board, corrugated board and foam board.

Strongest features

- High-performance cutting tool
- High processing speeds
- Availability of longer knife

Ideal for cutting:

- Triple walled cardboard
- Double walled cardboard
- Packaging Foam
- Honeycomb board ≥ 10 mm
- Foamcore with paper liner > 5 mm
- Re-board®
- Foamboard with plastic
- Rubber

Blades



500-9830 - POT Knife Flat Point L20 T0.63
Max cutting thickness - 18 mm



500-9831 - POT Knife Flat Point L27 T0.63
Max cutting thickness - 25 mm



500-9832 - POT Knife Flat Point L20 T1.5
Max cutting thickness - 18 mm



500-9833 - POT Knife Serrated L27 T1.0
Max cutting thickness - 25 mm



500-9834 - POT Knife Point L20 T1.0*
Max cutting thickness - 16 mm
*Extra protective mat recommended



Pneumatic Oscillating Tool - Long | POT-L



The Pneumatic Oscillating Tool-L (POT-L) is an addition to the standard POT and is used with a Longer type of knife. The POT-L is able to process thick, soft foams with a maximum thickness up to 42 mm. The robust construction of the tool makes it suitable to cut thick material, such as honeycomb board, corrugated board and foam board.

Strongest features

- High-performance cutting tool
- High processing speeds
- Availability of longer knife

Ideal for cutting:

- Triple walled cardboard
- Double walled cardboard
- Packaging Foam
- Honeycomb board ≥ 10 mm
- Foamcore with paper liner > 5 mm
- Re-board®
- Foamboard with plastic
- Rubber

Blades



500-9835 - POT-L Knife L50 T1.0*
Max cutting thickness - 42 mm
*POT-L Tool Only

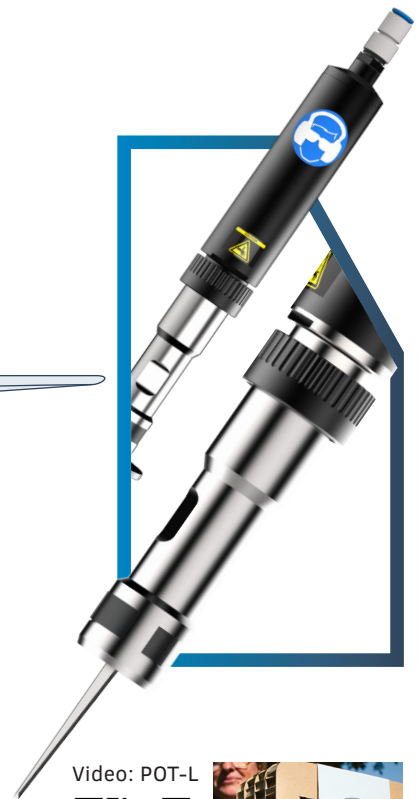

Video: POT-L



DRAG MODULE

The Drag Module enables users to make notations with pens or to kiss-cut materials with a pressure of 600 grams of downforce, using a drag knife.

Multiple Drag Modules can be mounted into the multi-functional head of the flatbed to allow both kiss-cutting and drawing without the need to change modules.

The Drag Module is standard included with all F Series models. The perfect module to start with!



Ideal for cutting:

- Paper < 200g
- Adhesive vinyl
- Sandblast material
- Window film

Drag Knife Tool

With 600 g of force, this tool is ideal for kiss-cutting a wide range of adhesive vinyls.

Strongest features

- Fast and precise
- Pinpoint kiss-cutting for easy weeding



391-231 - Drag Knife - 60°
Max cutting thickness - 0.6 mm



391-358 - Drag Knife - 55°
Max cutting thickness - 0.8 mm



391-360 - Standard Knife 36°
Max cutting thickness - 0.25 mm



Pen Tool & Universal Pen Holder Tool

The pen tool allows precise drawing on various materials, using either our own brand of fiber tip pens or a variety of third-party pencils and pens in a multitude of sizes and diameters.

Strongest features

- Precise drawing on various material types

Pens

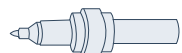

MP06BK
Fibre Tip Pen - Black



395-430/395-431
Roller Ball Pen
Black / Blue

Pen Holders



Universal Pen Holder / Black
accepts pen/pencils from 6.5 mm to 10 mm in diameter

Universal Pen Holder / Copper
accepts pen/pencils from 9.5 mm to 11 mm in diameter



ROTARY MODULE

The High Torque Rotary Module is driven by an electronic motor and is capable of handling all kinds of textiles. Thanks to extra rotational power, the HT RM is also able to cut tougher and thicker substrates, such as banner material.

Ideal for cutting:

- Uncoated woven polyester
- Coated woven polyester
- Laminated fabrics
- Canvas
- Fleece
- Felt
- Packaging foam
- Synthetic textiles
- Technical textiles

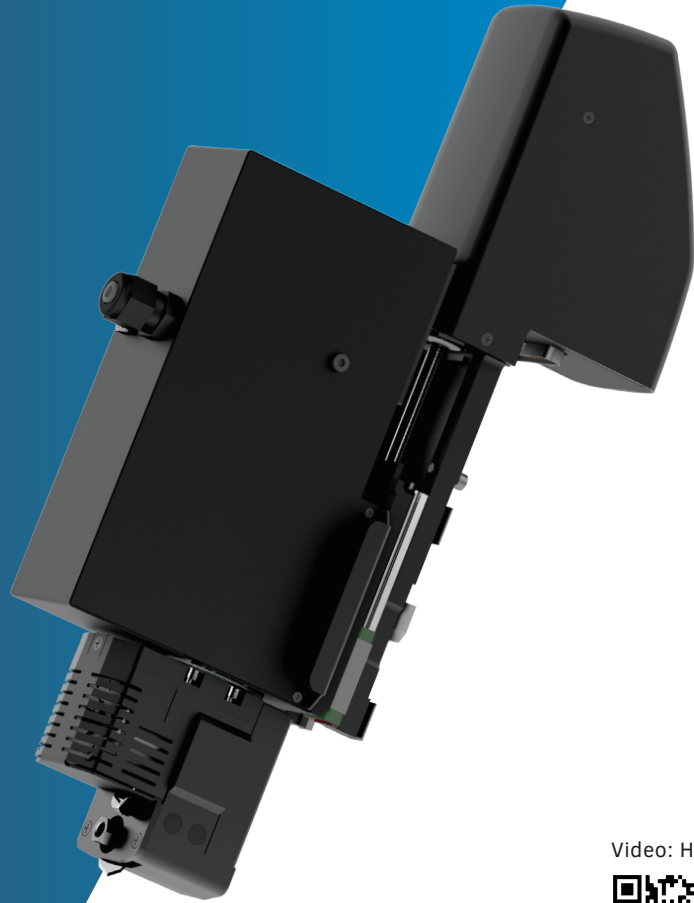

Video: HTRM



Take the production of your textile applications to the next level with the High Torque Rotary Module.

In general, the vacuum table of the F Series flatbed cutter has less grip on textiles. However, with the High Torque Rotary Module the material will stay in place thanks to the minimal horizontal force it produces. Consequently, also extremely porous material can easily be processed with the HT RM.



Strongest features

- Rotary blade reduces drag on material
- Motor-driven blade for reliable cutting
- Clean, precise cuts of all textile types



Decagonal Knives



500 - 9860
Decagonal Knife
D25
Max cutting thickness
- 1.5 mm

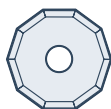

500 - 9861
Decagonal Knife
D28
Max cutting thickness
- 3 mm

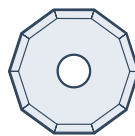

500 - 9862
Decagonal Knife
D32
Max cutting thickness
- 5 mm

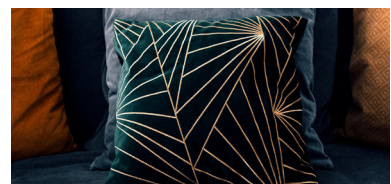

STANDARD ROUTER MODULE

The Standard Routing Module is available in two different power ratings and can handle most solid boards in the graphic and sign industry. Hard foam PVC, acrylic and aluminium covered foam boards as well as other materials, such as wood and MDF can be processed.

Power options:

- 1000W
- 1400W

Ideal for cutting:

- Expanded PVC board
- Corrugated PP Board
- Polycarbonate
- MDF
- Plexi
- ACP/ACM
- Foamcore with PVC liner
- Foamcore with HIPS liner



If you aspire to grow your business, you have to be ready to take on any job. Whether this means cutting 1.000 magnetic stickers, promotional board material for an upcoming sale, signage cutout of plexi or MDF, you need a system that is cut out for any job, each time again. With the standard router module, you will extend your cutting solutions considerably. The higher power on the 1400W router will even allow to process materials more than 30% faster than the 1000W router.



Strongest features

- Allows routing, engraving & polishing
- Processes a wide range of substrates
- Efficient dust extraction for clean operation (optional vacuum cleaning kit)
- Excellent edge finishing
- Availability of various bits



Routing Bits

500-9850 - Routing Bit D3/3 L38/11 1FI UC



500-9863 - Routing Bit D6/10 L50 90° B 2FL

500-9852 - Routing Bit D4/4 L50/12 1FI UC



500-9864 - Routing Bit D6/6 L50/22 2FL UC/DC

Go to:
Summa Router
bits overview



HF ROUTER MODULE

The HF Routing Module is equipped with a high-frequency spindle and a higher power output, which allow higher processing speeds. The utmost balanced, high-frequency spindle provides for a much smoother finishing of rigid substrates. The bit is pneumatically controlled and can be replaced manually in a fast and simple way.

Ideal for cutting:

- Expanded PVC board
- Corrugated PP Board
- Polycarbonate
- MDF
- Plywood
- Natural Hardwood
- Plexi
- ACP/ACM
- Foamcore with PVC liner
- Foamcore with HIPS liner

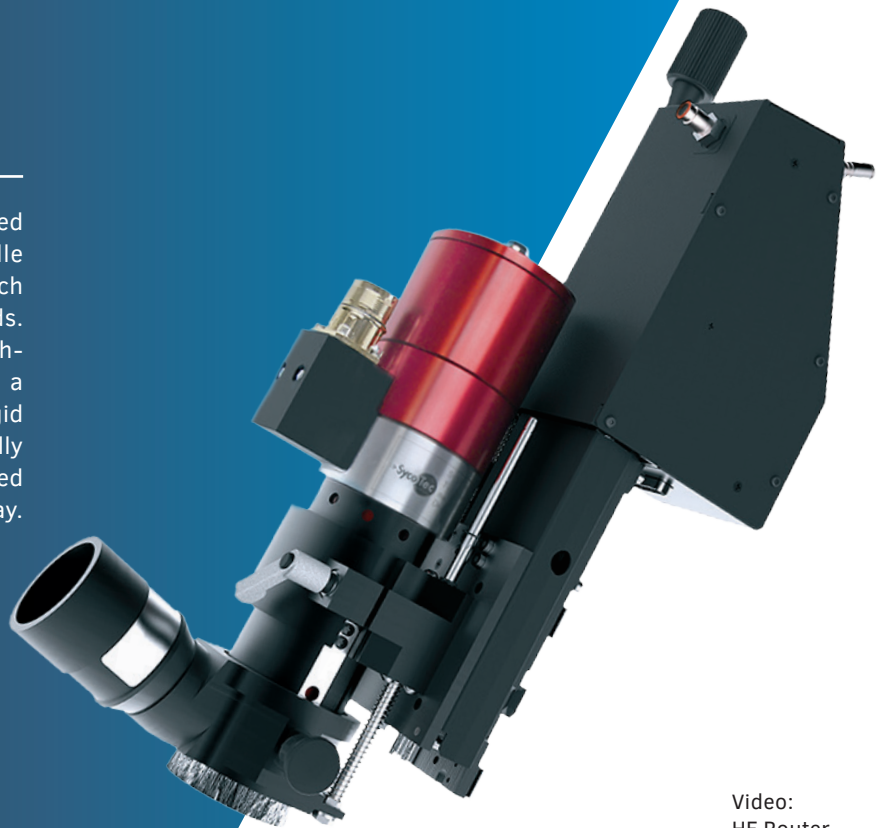

Video:
HF Router



Especially for high-production environments, the High Frequency Router module will prove its worth. So, if you process tough, rigid material types on a regular basis and you want the job to be done rapidly and efficiently, the HF router is your first choice tool. Achieve exceptional performance and productivity with the high-frequency spindle and deliver top-quality products with impeccable edge finishing.



Strongest features

- Maximises productivity
- Higher processing speeds
- Robust, reliable construction
- Impeccable edge finishing
- Efficient dust extraction for clean operation (optional vacuum cleaning kit)
- Availability of various bits



Routing Bits



500-9854 - HF Routing Bit D6/3 L50/06 MP 1FI UC



500-9857 - HF Routing Bit D6/6 L50/12 MP 1FI UC BAL



500-9856 - HF Routing Bit D6/4 L50/12 MP 1FI UC



500-9858 - HF Routing Bit D6/6 L58/22 MP 1FI UC BAL



500-9859 - HF Routing Bit D6/6 L50/14 POLISHING

Go to:
Summa Router
bits overview



Tools | Application Overview

| | Drag Module | Standard Routing Module | HF Routing Module | High Torque Rotary Module | Tangential Module | | | | | | | | | | | |
|--------------------------------|-------------|-------------------------|-------------------|---------------------------|-------------------------------|-------------------------------|-------------------------------|----------------------------------|---------------------------------|---------------------------------|-------------------|-------------------|---------------------|---------------------------|---|--|
| | | | | | Kiss Cut Tool + 390-534 knife | Kiss Cut Tool + 390-560 knife | Kiss Cut Tool + 390-550 knife | Single Edge Cutout Tool 500-9312 | Double Edge Cutout Tool 500-931 | Heavy Duty Cutout Tool 500-9314 | EOT Tool 500-9320 | POT Tool 500-9350 | POT-L Tool 500-9358 | Perforating Tool 500-9315 | | |
| Recommended | | | | | | | | | | | | | | | | |
| Alternative | | | | | | | | | | | | | | | | |
| CARDBOARD MATERIALS | | | | | | | | | | | | | | | | |
| Paper < 200 gsm | | | | | | | | | | | | | | | | |
| Cardboard 300-500 gsm | | | | | | | | | | | | | | | | |
| Corrugated B flute (3 mm) | | | | | | | | | | | | | | | | |
| Corrugated C flute (4 mm) | | | | | | | | | | | | | | | | |
| Corrugated BC flute (7 mm) | | | | | | | | | | | | | | | | |
| Corrugated E flute (1.5 mm) | | | | | | | | | | | | | | | | |
| Honeycomb board < 10 mm | | | | | | | | | | | | | | | | |
| Honeycomb board >= 10 mm | | | | | | | | | | | | | | | * | |
| ROLL MATERIALS | | | | | | | | | | | | | | | | |
| Adhesive vinyl | | | | | | | | | | | | | | | | |
| Adhesive PVC banner vinyl | | | | | | | | | | | | | | | | |
| PVC Banner | | | | | | | | | | | | | | | | |
| Mesh Banner | | | | | | | | | | | | | | | | |
| Sandblast material | | | | | | | | | | | | | | | | |
| Reflective sheeting | | | | | | | | | | | | | | | | |
| Window film | | | | | | | | | | | | | | | | |
| Magnetic | | | | | | | | | | | | | | | | |
| SYNTHETIC MATERIALS | | | | | | | | | | | | | | | | |
| Corrugated PP board <= 5 mm | | | | | | | | | | | | | | | | |
| Corrugated PP board > 5 mm | | | | | | | | | | | | | | | | |
| Expanded PVC board <= 2 mm | | | | | | | | | | | | | | | | |
| Expanded PVC board > 2 mm | | | | | | | | | | | | | | | | |
| Polypropylene sheets <= 1.2 mm | | | | | | | | | | | | | | | | |
| Polycarbonate <= 0.6 mm | | | | | | | | | | | | | | | | |
| Polycarbonate > 1 mm | | | | | | | | | | | | | | | | |
| Plexi | | | | | | | | | | | | | | | | |
| PET < 1.2 mm | | | | | | | | | | | | | | | | |
| PET < 2 mm | | | | | | | | | | | | | | | | |
| COMPOSITES | | | | | | | | | | | | | | | | |
| Foamcore with paper liner | | | | | | | | | | | | | | | | |
| Foamcore with HIPS liner | | | | | | | | | | | | | | | | |
| Foamcore with PVC liner | | | | | | | | | | | | | | | | |
| ACP/ACM | | | | | | | | | | | | | | | | |
| WOOD | | | | | | | | | | | | | | | | |
| MDF | | | | | | | | | | | | | | | | |
| Plywood | | | | | | | | | | | | | | | | |
| Natural Hardwood | | | | | | | | | | | | | | | | |
| TEXTILES | | | | | | | | | | | | | | | | |
| Uncoated woven polyester | | | | | | | | | | | | | | | | |
| Coated woven polyester | | | | | | | | | | | | | | | | |
| Laminated Fabrics | | | | | | | | | | | | | | | | |
| Canvas | | | | | | | | | | | | | | | | |
| INDUSTRIAL MATERIALS | | | | | | | | | | | | | | | | |
| Varnish blankets | | | | | | | | | | | | | | | | |
| Gasket | | | | | | | | | | | | | | | | |
| Insulation foam | | | | | | | | | | | | | | | * | |
| Textiles (Coated-Uncoated) | | | | | | | | | | | | | | | | |
| Rubber | | | | | | | | | | | | | | | * | |
| * min. thickness 20 mm | | | | | | | | | | | | | | | | |

Tools | Application Overview

| | V-Cut Tool 0° 500-9340 | V-Cut Tool 15° 500-9341 | V-Cut Tool 22.5° 500-9342 | V-Cut Tool 30° 500-9343 | V-Cut Tool 45° 500-9344 | Creasing Tool D25 R3 W8 500-9325 | Creasing Tool D25 R1.5 W8 500-9326 | Creasing Tool D25 R0.75 W1.5 500-9327 | Creasing Tool D15 R0.35 W0.7 2pt 500-9328 | Creasing Tool D15 R0.17 W0.35 1pt 500-9329 | Creasing Tool D50 R1.5 500-9324 |
|--------------------------------|---------------------------|----------------------------|------------------------------|----------------------------|----------------------------|--|--|---|---|---|---------------------------------------|
| Recommended | | | | | | | | | | | |
| Alternative | | | | | | | | | | | |
| CARDBOARD MATERIALS | | | | | | | | | | | |
| Paper < 200 gsm | | | | | | | | | | | |
| Cardboard 300-500 gsm | | | | | | | | | | | |
| Corrugated B flute (3 mm) | | | | | | | | | | | |
| Corrugated C flute (4 mm) | | | | | | | | | | | |
| Corrugated BC flute (7 mm) | | | | | | | | | | | |
| Corrugated E flute (1.5 mm) | | | | | | | | | | | |
| Honeycomb board < 10 mm | | | | | | | | | | | |
| Honeycomb board >= 10 mm | | | | | | | | | | | |
| ROLL MATERIALS | | | | | | | | | | | |
| Adhesive vinyl | | | | | | | | | | | |
| Adhesive PVC banner vinyl | | | | | | | | | | | |
| PVC Banner | | | | | | | | | | | |
| Mesh Banner | | | | | | | | | | | |
| Sandblast material | | | | | | | | | | | |
| Reflective sheeting | | | | | | | | | | | |
| Window film | | | | | | | | | | | |
| Magnetic | | | | | | | | | | | |
| SYNTHETIC MATERIALS | | | | | | | | | | | |
| Corrugated PP board <= 5 mm | | | | | | | | | | | |
| Corrugated PP board > 5 mm | | | | | | | | | | | |
| Expanded PVC board <= 2 mm | | | | | | | | | | | |
| Expanded PVC board > 2 mm | | | | | | | | | | | |
| Polypropylene sheets <= 1.2 mm | | | | | | | | | | | |
| Polycarbonate <= 0.6 mm | | | | | | | | | | | |
| Polycarbonate > 1 mm | | | | | | | | | | | |
| Plexi | | | | | | | | | | | |
| PET < 1.2 mm | | | | | | | | | | | |
| PET < 2 mm | | | | | | | | | | | |
| COMPOSITES | | | | | | | | | | | |
| Foamcore with paper liner | | | | | | | | | | | |
| Foamcore with HIPS liner | | | | | | | | | | | |
| Foamcore with PVC liner | | | | | | | | | | | |
| ACP/ACM | | | | | | | | | | | |
| WOOD | | | | | | | | | | | |
| MDF | | | | | | | | | | | |
| Plywood | | | | | | | | | | | |
| Natural Hardwood | | | | | | | | | | | |
| TEXTILES | | | | | | | | | | | |
| Uncoated woven polyester | | | | | | | | | | | |
| Coated woven polyester | | | | | | | | | | | |
| Laminated Fabrics | | | | | | | | | | | |
| Canvas | | | | | | | | | | | |
| INDUSTRIAL MATERIALS | | | | | | | | | | | |
| Varnish blankets | | | | | | | | | | | |
| Gasket | | | | | | | | | | | |
| Insulation foam | | | | | | | | | | | |
| Textiles (Coated-Uncoated) | | | | | | | | | | | |
| Rubber | | | | | | | | | | | |

MEDIA HANDLING & WORKFLOWS

The Summa F Series flatbed systems offer many intelligent and efficient media handling features to optimise and future-proof your cutting workflow. A number of them are integrated, others can be retrofitted at any given time.

So, go ahead and add another shift to your F Series operation with our large gamut of media handling add-ons and options to obtain ultimate production efficiency, reduce operator intervention and enhance overall ease-of-use.



Enhanced productivity with efficient media handling

The F Series flatbed cutters are equipped with a range of media handling features that are standard included with each model. Also a range of model-specific media handling add-ons is available to further enhance operator convenience and productivity. You can find a detailed overview of the specific media handling possibilities per model in the product sheets.

1. Conveyor System

The Conveyor System allows you to cut, crease and annotate large lengths of (flexible) material to large production runs. The conveyor automatically transports cut parts away from the cutting area. This allows the production of jobs that are longer than the actual working area of the flatbed cutter.

2. Media Advance Clamps

Pneumatically-driven media advance clamps fix the material while pulling it forward to work continuously in panels or while processing multiple jobs.

3. Roll Support System

In combination with the Conveyor System and the Media Advanced Clamps, the Roll Support System is ideal for processing roll material on all the Summa F Series models.

4. Vacuum Table

The vacuum table generates hold-down force to keep the material in place during the cutting process while the selector adjusts the vacuum automatically to match the working area.

The vacuum table can be set up with zones that can be turned on or off in case you want to process smaller jobs.

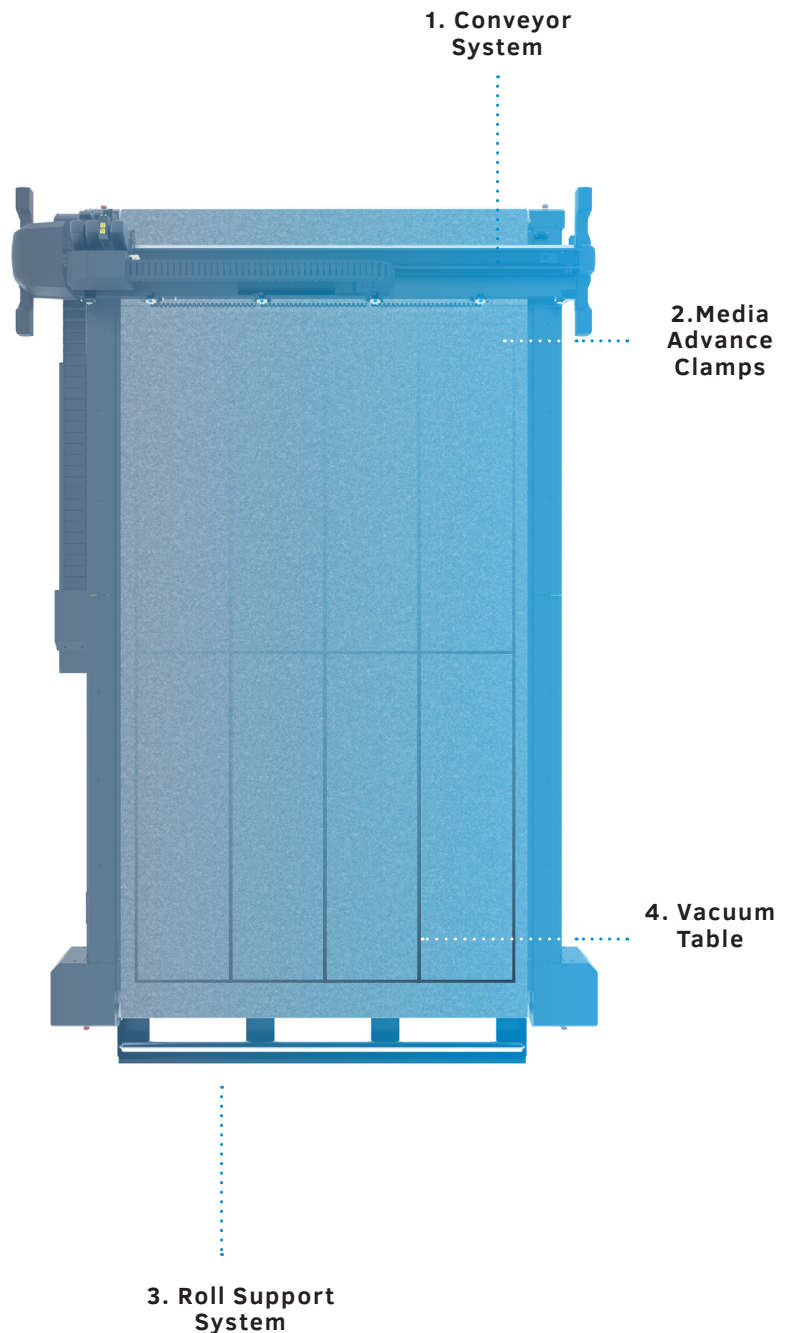

A workflow to anyone's need

The F Series flatbed cutters allow to streamline the cutting workflow to your specific business needs. The different available workflows contribute to the flatbed's ease-of-use, minimise operator intervention and increase yield considerably. The below workflows are standard included with all F Series models, unless otherwise specified.



Operator Zone

With this feature the F Series' working area can be divided into two separate zones, a cut only zone and an Operator Zone. The included Conveyor system automatically feeds all cut material forward to the Operator zone. The cutting head doesn't move any further than the cut only zone, so the operator has access to the cut pieces safely at the front of the machine.



Poster Trim

This feature enables a fast cutting of posters without the need of importing any cutting data. The F Series built-in camera system automatically detects the edges of black printed frames and starts to cut immediately, without operator intervention. The Poster Trim functionality is the ideal way to make sure your posters are cut rapidly and precisely with a minimum of manual actions.

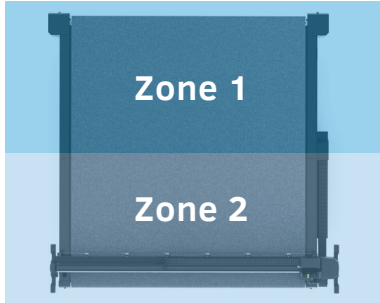

Tandem Mode for F1432, F1832, F3232

By using the front zones and rear zones alternately, this feature leads to significant production increase. With the Tandem Mode, the active working area on the flatbed can be divided into front and back processing areas, enabling the user to load and unload material on one end of the table while cutting material on the other end of the table. This will avoid idle periods during cutting, which will add significant value to the overall workflow.



Twin Workflow

To maximise productivity and flexibility in your finishing workflow, you can use the Twin Workflow. The Twin workflow combines the strength of a Summa roll cutter with an F Series flatbed cutter, meaning you can kiss-cut on the roll cutter and cut through on the F Series flatbed cutter.

The Twin Workflow has been developed for users that want to optimise the use of their equipment in a most efficient way. By using one of these workflows, productivity and performance will be brought to a higher level. The smooth integration of the cutters into existing workflows will further contribute to the customer's Productivity, Performance and Profitability!

Videos:

Operator Zone



Poster Trim



Tandem Mode



Twin Workflow



Barcode Workflow

Certain RIP (Raster Image Processing) software offer the possibility to print a barcode with OPOS marks. This barcode can be used to identify the job and to automatically obtain the necessary cut data from the computer. Summa offers two possible ways to scan in a job.

With the Summa F Series built-in camera

With this F Series' optional barcode setup, scanning the job happens automatically and continuously by the built-in camera. The operator doesn't need to locate the job himself anymore. The job will be opened automatically in GoProduce to be processed immediately.

The greatest asset of Summa's revolutionary camera system is that the camera will search for the next job without operator intervention.

With a hand scanner

Another means to offer flexibility to the operator's workflow is scanning the job manually with a hand scanner.

This way the operator can easily switch between jobs and materials. Multiple, different jobs can be processed back to back with ease.

This feature is embedded in the GoProduce software. However, the hand scanner itself is not included and needs to be purchased separately.

Activation

The barcode workflow is included in the GoProduce Pro Pack software.

Video:
Barcode
Workflow

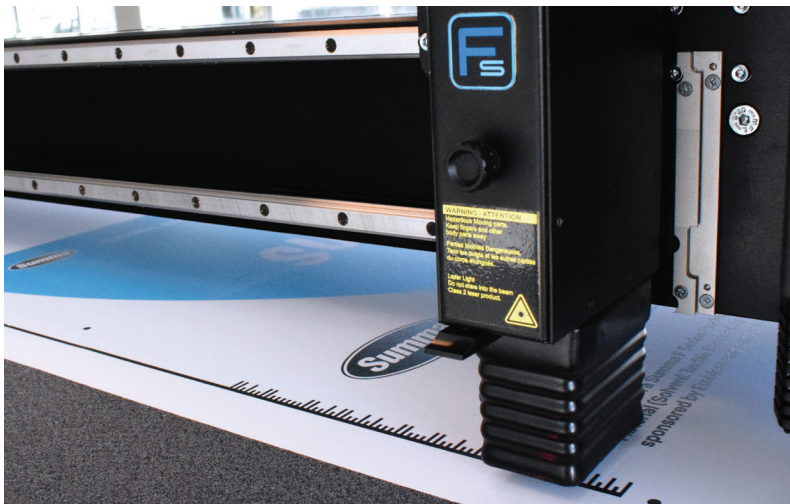

Barcode Workflow with Summa's built-in camera



Barcode Workflow with hand scanner

F-Performance

The F-Performance mode ensures an increase of up to **40%** of the F Series' performance. Advantages include faster up, down and turning movements of the cutting head, which will be most remarkable when using the Kiss-cut tool. Also, feeding material will happen significantly faster. The job will be finished practically twice as fast without compromising an inch on quality.

The F-Performance mode is available as free unlock on new machines via www.Summa.com/f-performance and as payable unlock on older F Series models, built before 2018.

Video:
F-Performance



“The usage of the **F-Performance mode** on the F1612 made a huge difference to our production speed. The small gains on feed speed and tool movement really add up to give us around **30% additional productivity** on this particular project.”

/ Freestyle Design about F-Performance



Workflow Compatibility

The Workflow Compatibility of the Summa GoProduce software ensures a seamless fit into existing workflows. The software offers flexible data import and is supported by the following RIP manufacturers:

RIP manufacturers:

Agfa Asanti
 Cadlink RIP
 Caldera RIP
 ColorGATE RIP
 ErgoSoft PosterPrint
 ErgoSoft TexPrint
 GMG Production Suite
 ONYX RIP
 Wasatch RIP
 SAI- FLEXI

Packaging Software Compatibility:

Arden
 Picador

1. Prepare design



... RIP

2. Print & setup

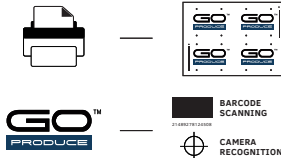

3. Finish

F SERIES™

Testimonial | TrafficSupply

“WITH THE F1612 FLATBED CUTTER, THE JOB IS DONE IN AN INSTANT.”

Company: TrafficSupply

Core business: Traffic signs

Challenge: Keep up with demand

Solution: Summa F1612

The Story | A typical F1612 workflow starts with a simultaneous setup of the print and cut file. As soon as the printing and lamination part is finished, the roll with reflective foil is placed onto the roll-up system. Then advanced by the conveyor onto the F1612 flatbed cutter surface.

Subsequently, the cutter reads the barcode printed on the design and starts processing the correct file. By scanning the registration marks the cutter knows exactly how the roll is positioned onto the table – compensates if necessary – and starts to cut. Fast and efficiently.



“If we hadn’t purchased the F1612, we would’ve surely needed to employ more staff. With the F1612, the job is now done in an instant. Precisely, rapidly and straightforwardly.”

/ TrafficSupply about F1612

Media Handling Add-ons for F1612



Basket

The Basket is a handy accessory to reduce the media handling time, thus optimising your workflow. The F1612 can automatically process several feet of material while the basket is capturing the cut-out vinyl and/or waste material. Rely on an efficient cutting workflow and a clean work environment.



Extension Tables for Continuous Sheet Feed

The sturdy, foldable Extension Tables can be placed in front and at the back of the F1612. They are adjustable to set the correct height. This way, board material longer than the F1612 working area can still be processed. With the extension tables you can use the Continuous Sheet Feed feature, this enables the user to load and unload material while cutting. The feature helps to avoid idle periods during the processing of material and thus adds significant value to the overall workflow.



Roll-Up System

When kiss-cutting, the roll-up system winds the material back on a roll after it has been cut. This allows the F1612 to work unattended, while keeping the work area neat and clean. When cutting through, a workflow can be set up in combination with the basket or extension table. The roll-up takes care of the waste matrix while the operator collects the cutout material. The winded roll is also easily accessible for trolleys or other tools to handle heavy rolls.



Conveyor Extension

Thanks to the conveyor extension, the F1612 makes light work of cut designs, that are much larger than their actual cutting area. Once the first part of the job is completed, the conveyor feeds the cut material to the extended front where it can be removed easily and safely, while the machine is cutting the next part. This minimises downtime considerably. *Note: All existing F1612 units in the field can be upgraded with this option.*

Media Handling Add-on for F1832, F3220, F3232

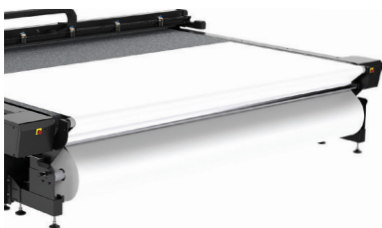

Heavy-Duty Roll Support

The Heavy-Duty Roll Support can be used on our wide-format flatbed sizes to allow a straight and effortless throughput of heavy print rolls before cutting the material. Especially for the processing of heavy banner material, non-stretchable wide textile rolls and lightly stretchable materials, the HD RS will prove its worth. It will even allow the processing of rolls up to 200 kg with ease.

Videos:

Continuous Sheet Feed



Conveyor Extension



Heavy-Duty Roll Support





SUMMA IN-HOUSE DEVELOPED SOFTWARE

The Summa GoSuite software platform has been developed in-house to enable users to make the most of their print and cut workflow. With the Summa software, operators, designers and business owners, can easily process and analyse complex and high volume jobs with great flexibility.

Rely on powerful software to maximise the use of your Summa cutting equipment.



The user-friendly GoProduce software is part of Summa's GoSuite platform. GoProduce is developed for the operator of the F Series, handling jobs in a straightforward and easy way. The modern interface with improved navigation enables users to find and operate functions as quickly and intuitively as possible.



- Modern interface
- Improved navigation
- Quick and intuitive
- Windows-based
- Standard included
- Pro Pack available
- 30-day Trial available

Key Features (standard included)

Material Manager

The material database includes an extensive range of material types which settings can be adapted to your specific needs. Through methods, you only need to choose the material you want to process. Then, the material manager automatically chooses the correct tool and its settings for the cutting job.

Overcut Compensation

This GoProduce functionality avoids or minimises overcuts in the corners.

Sorting

The order in which objects are handled is important to minimise output time. GoProduce can determine the start and end of a vector and the order of processing. The aim here is to shorten the traverse path. Basic sorting is done by GoProduce itself.

Milling

With the interactive milling function, any change in tool diameter and rotation is performed immediately and shown on the working area. All milling paths are automatically created and displayed; the tool diameter is taken into account.

Camera Recognition

The recognition process and localisation of the registration marks can be tracked in the camera preview window. All kinds of compensations and marks, which occur in everyday practice, are manageable with GoProduce.

Back Side Cutting IMPROVED

Back side cutting is especially useful when cutting cardboard boxes in order not to damage the print and in order to ensure the print is located at the outside.

How to get started

Choose the functionalities you need and discover the software with a free 30-day trial on our website.

Knowledge Base:

Frequently asked questions have been bundled and answered by Summa experts in a knowledge database. Gradually, we will be extending the database with more tutorials, service-related topics and useful tips&tricks. Go to: www.summa.com/faq or scan the QR code.

Also, various tutorials are created to support you in the installation and use of Summa GoProduce.

TIP | Scan the QR code to watch all GoProduce tutorials on Summa's Youtube page.

Website:

Free 30-day trial



FAQ



Videos:

Back Side Cutting



GoProduce Tutorials



GoProduce™ Pro Pack

The optional GoProduce Pro Pack offers you advanced features such as barcode functionality, hot folder support, Twin Workflow and import possibility of plot files. Similar to the standard GoProduce software, also the Pro Pack will be gradually expanded with new functionalities.

Hot folder support

GoProduce could already import jobs by file selection by means of a hand scanner or OPOS barcode. With the hot folder functionality in GoProduce 2.0, files dropped in a folder can now be opened automatically in GoProduce.

Twin X - Import of plot files

Twin X enables GoProduce to read cutting files prepared for Summa Roll cutters. This way the Twin workflow, previously only available on OPOS CAM roll cutter units - can now also be used on all Summa roll cutter units, equipped with an OPOS X sensor.

Barcode functionality

The previous GoProduce barcode option is no longer available and is now converted to the Pro Pack.

| GoProduce 2.0 | GoProduce 2.0 Pro Pack |
|--|--|
| Standard available on www.Summa.com | One-time Pro version purchase (395-995) |
| <ul style="list-style-type: none"> • Custom configuration of action sets | <ul style="list-style-type: none"> • Custom configuration of action sets |
| <ul style="list-style-type: none"> • Registration of square / round marks | <ul style="list-style-type: none"> • Registration of square / round marks |
| <ul style="list-style-type: none"> • Material manager | <ul style="list-style-type: none"> • Material manager |
| <ul style="list-style-type: none"> • Job log functionality | <ul style="list-style-type: none"> • Job log functionality |
| <ul style="list-style-type: none"> • Cut-off between jobs | <ul style="list-style-type: none"> • Cut-off between jobs |
| <ul style="list-style-type: none"> • Tool priority selector | <ul style="list-style-type: none"> • Tool priority selector |
| <ul style="list-style-type: none"> • Remote controller | <ul style="list-style-type: none"> • Remote controller |
| <ul style="list-style-type: none"> • Weedbox functionality | <ul style="list-style-type: none"> • Weedbox functionality |
| <ul style="list-style-type: none"> • Back side cutting edge-detection | <ul style="list-style-type: none"> • Back side cutting edge-detection |
| | <ul style="list-style-type: none"> • Barcode functionality |
| | <ul style="list-style-type: none"> • Hot folder support |
| | <ul style="list-style-type: none"> • Twin X - Import plot files |



PLM Packlib: Summa's packaging library

The PLM Packlib* for Summa is a library of resizable standard packaging models. The most popular packaging standards FEFCO (corrugated cardboard) and ECMA (folding carton) are included. Also a few POS display designs and solid cardboards (furniture) designs are available.

Box/design dimensions and material thickness are parametric. So, within a few clicks the correct cutting and folding lines are generated. These lines can be exported to a layered Illustrator file, ready to put graphics on it. This 'Summa version' also has the option to generate an OXF file, immediately ready to be used by GoProduce.

You can download Summa's packaging library via www.summa.com. If you want to enjoy additional packaging features or if you need support on the packaging library, please contact TreeDim via support@treedim.com.

Key features

- Ideal entry into the packaging industry
- Easy standard packaging designs



*PLM Packlib is a program from TreeDim known by 'Picador' software.

Go to:
PLM Packlib
Information



Go to www.summa.com/faq/how-to-use-the-packlib-library for more information

Axis Control™

Axis Control™ software gives you full control over Summa's cutting table. The optimised design of the touchscreen makes Axis Control the optimum interface for the machine operator.

With the optional wireless controller, the operator is free to move around the table while changing basic settings.

Key features

- Machine operating software
- Easy calibration of tools
- Optimising vacuum zone



*Summa Axis Control is standard included with every flatbed purchase

Product Registration

Summa recommends users to register their products online. Upon registration of your Summa products, you can activate several features such as the F-Performance, barcode, and so on. Also, in the registration form, you can choose to tick the box if you want to receive our monthly newsletter. This way, you can stay up to date with Summa's latest products and features that might complement your cutting equipment.

All Summa products can be registered through the Summa website.

Inspiring Customer Stories

Customer stories capture an extensive range of end-user experiences. Experiences they gain by operating our Summa cutting equipment daily, week in week out, year in year out. These stories will help you in obtaining a better understanding of the many reasons why a Summa product might just be the gamechanger you were looking for to bring your cutting workflow to the highest possible level.

Customer stories go beyond product leaflets, brochures and other presentations. These real-life views and opinions from people in the field are the actual depiction of a product's benefits as shown in a true production area. So, go ahead and read our blog, which is filled with inspiring customer stories to create innovative and striking applications with our Summa equipment that fits your every cutting need!

Go to:

Product Registration



Summa Blog



Testimonial | CD Design

“THE SUMMA F1612 FLATBED FINISHING SYSTEM SIMPLY OFFERS THE PERFECT SOLUTION TO FINISH THE JOB”

Company: CD Design Glasfolie
Core business: Window films
Challenge: Accurate & fast cutting
Solution: Summa F1612 & F1832

The Story | Before the arrival of their first Summa flatbed cutter everything was cut manually or with a Summa D160 roll cutter at CD Design. However, the window film market was growing constantly and the substrates were often too thick to cut with a roll cutter. The purchase of their first flatbed finishing system thus became indispensable very soon. Meanwhile, both an F1612 and an F1832 flatbed cutter are operational - one in each of CD Design's facilities.

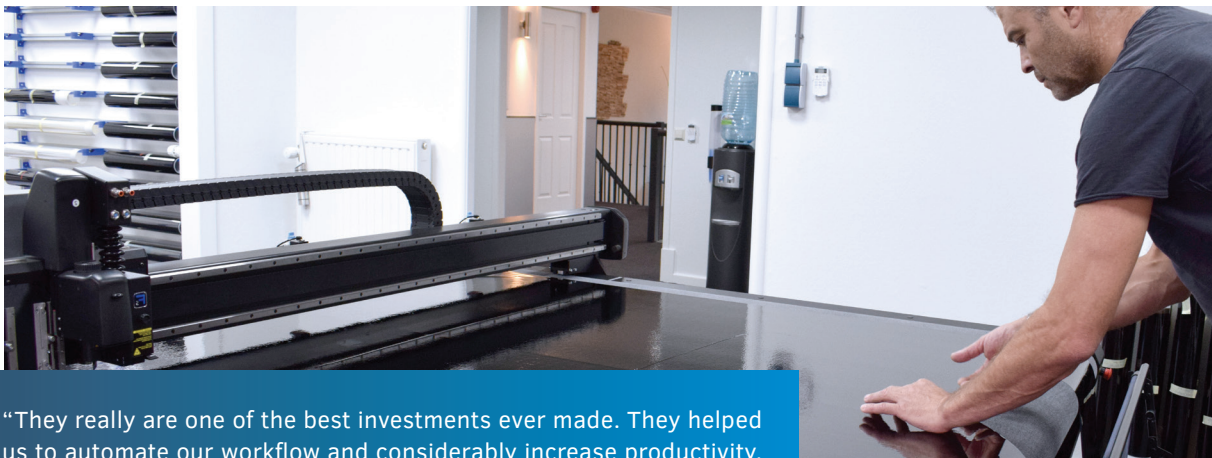

“They really are one of the best investments ever made. They helped us to automate our workflow and considerably increase productivity. Additionally, the flatbeds enabled our employees to work a lot more efficiently and finish significantly more jobs per day. Subsequently, our customer database has grown, so we can honestly say ‘sky is the limit’ thanks to these two wonderful Summa flatbeds.”

/ CD Design Glasfolie about investing in a F1612 & F1832



TECHNICAL SPECIFICATIONS

| Model | F1612 | F1432 | F1832 |
|---------------------|---|---|--|
| Dimensions | 247 x 220 x 110 cm | 230 x 422 x 122 cm | 279 x 422 x 122 cm |
| Media Width | Up to 165 cm | Up to 134 cm | Up to 190 cm |
| Working Area | 160 x 120 cm | 136 x 320 cm | 184 x 320 cm |
| Vacuum | 1.3 kW (50Hz) / 1.75 kW (60Hz) | 2.2 kW (50Hz) / 2.55 kW (60Hz) | 2 x 2.2 kW (50Hz) / 2 x 2.55 kW (60Hz) |
| Vacuum Zones | Variable over width of machine | 6 zones (2 rows x 3 columns) | 8 zones (2 rows x 4 columns) |
| Requirements | Standard: 3 x 400V + N, 50Hz, max 20A Or: 3 x 208V + N, 60Hz, max 30A Or: 3 x 230V, 50Hz, max 20A | Standard: 3 x 400V + N, 50Hz, max 30A Or: 3 x 208V + N, 60Hz, max 30A Or: 3 x 230V, 50Hz, max 30A | Standard: 3 x 400V + N, 50Hz, max 30A Or: 3 x 208V + N, 60Hz, max 30A Or: 3 x 230V, 50Hz, max 30A |
| Model | F3220 | F3232 | All standard solutions incl. |
| Dimensions | 422 x 313 x 122 cm | 422 x 422 x 122 cm | <ul style="list-style-type: none"> • F Series Flatbed System • Conveyor System • Pneumatic Media Clamps • Roll Support • Camera System • Axis Control Software • Drag Module • ADC Right • ADC Left • GoProduce software • Speed: up to 1000 mm/sec • Acceleration: Up to 1G |
| Media Width | Up to 332 cm | Up to 332 cm | |
| Working Area | 327 x 210 cm | 327 x 320 cm | |
| Vacuum | 4.0 kW (50Hz) / 4.6 kW (60Hz) | 2 x 2.2 kW (50Hz) / 2 x 2.55 kW (60Hz) | |
| Vacuum Zones | 7 zones (1 row x 7 columns) | 14 zones (2 rows x 7 columns) | |
| Requirements | Standard: 3 x 400V + N, 50Hz, max 30A Or: 3 x 208V + N, 60Hz, max 30A Or: 3 x 230V, 50Hz, max 30A | Standard: 3 x 400V + N, 50Hz, max 30A Or: 3 x 208V + N, 60Hz, max 30A Or: 3 x 230V, 50Hz, max 30A | |

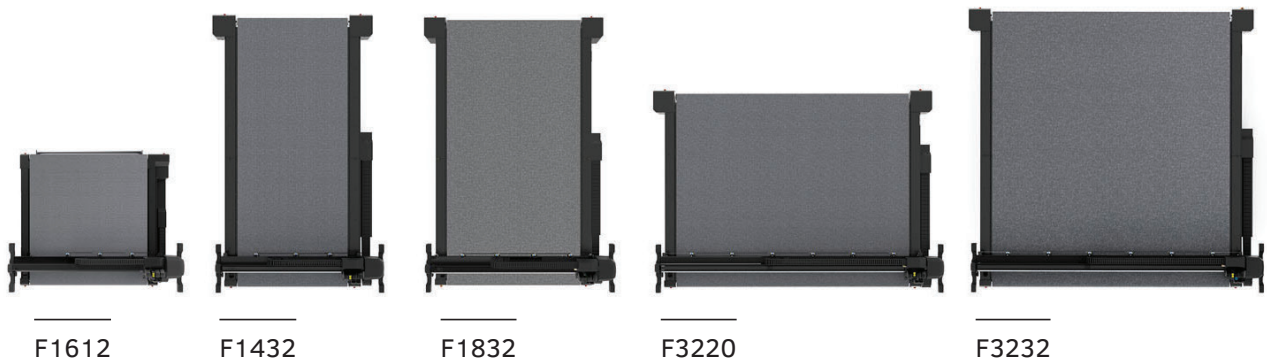

F1612

F1432

F1832

F3220

F3232

ORDER CODES

Order codes: Consumables

Drag Module

| | |
|-------------|---------------------------------|
| 391-332 | Drag Knife Holder for 36° & 60° |
| 9TL89-67041 | Standard Drag Knives - 36° (5x) |
| 391-231 | Drag Knife - 60° |
| 391-358 | Drag Knife - 55° |
| 391-360 | Drag Knife - 36° |
| MP06BK | Fibre Tip Pens - Black (4x) |
| 395-430 | Roller Ball Pens - Black (5x) |
| 395-431 | Roller Ball Pens - Blue (5x) |
| 395-434 | Pen Holders |

Tangential Module - Blades

| | |
|----------|---|
| 390-534 | Standard Tangential Knife - 36° (5x) |
| 390-550 | Sandblast Tangential Knife - 60° |
| 390-551 | Double Tip Tangential Knife - 36° |
| 390-560 | Tangential Knife 45° Wedge 40/25° |
| 390-553 | Knife Install Tool |
| 395-348 | Nose Piece for 36° |
| 500-9801 | Single Edge Cutout Knife - 65° |
| 500-9802 | Double Edge Cutout Knife - 50° |
| 500-9803 | Double Edge Cutout Knife - 60° |
| 500-9804 | Double Edge Cutout Knife - 50° / Burr- Free |
| 500-9807 | Heavy-Duty Cutout Knife - 45° / 90° |
| 500-9825 | V-Cut Blade - 0.9 mm (5x) |
| 500-9826 | V-Cut Blade - Hard Metal |
| 500-3303 | Gliding Disk Single Sided Knife |
| 500-3315 | Gliding Disk Double Sided Knife |
| 500-9890 | Perforation Knife 1x1 mm D1.1mm (12TPI) |
| 500-9891 | Perforation Knife 1.7x1.7 mm D1.1mm (8TPI) |
| 500-9892 | Perforation Knife 3x3 mm D4mm (4TPI) |
| 500-9893 | Perforation Knife 5x5 mm D4mm (3TPI) |

Electronic Oscillating Tool / EOT

| | |
|----------|---------------------------|
| 500-3313 | Knife Guide for EOT |
| 500-9800 | EOT Knife L25 - 65° |
| 500-9810 | EOT Knife L25 - 65° - 80° |
| 500-9811 | EOT Knife L25 - 65° - 85° |
| 500-9812 | EOT Knife L28 - 65° - 85° |
| 500-9813 | EOT Knife L25 - 0° - 65° |
| 500-9814 | EOT Knife L38 - 45° - 86° |
| 500-9815 | EOT Knife L33 - 45° - 85° |

Pneumatic Oscillating Tool POT / POT-L

| | |
|----------|-------------------------------------|
| 500-9830 | POT Knife Flat Point L20 T0.63 (3x) |
| 500-9831 | POT Knife Flat Point L27 T0.63 (3x) |
| 500-9832 | POT Knife Flat Point L20 T1.5 (3x) |
| 500-9833 | POT Knife Serrated L27 T1.0 (3x) |
| 500-9834 | POT Knife L20 T1.0 (3x) |
| 500-9835 | POT-L Knife L50 T1.0 (3x) |

High Torque Rotary Module

| | |
|----------|--------------------------|
| 500-9860 | Decagonal Knife D25 (3x) |
| 500-9861 | Decagonal Knife D28 (3x) |
| 500-9862 | Decagonal Knife D32 (3x) |

Routing System

| | |
|----------|--|
| 500-9850 | Routing Bits D3/3 L38/11 1FI UC (3x) |
| 500-9852 | Routing Bits D4/4 L50/12 1FI UC (3x) |
| 500-9863 | Routing Bits D6/10 L50 90° B 2FI (2x) |
| 500-9864 | Routing Bits D6/6 L50/22 2 FI UC/DC (2x) |
| 500-9854 | HF Routing Bits D6/3 L50/06 MP 1FI UC (3x) |
| 500-9856 | HF Routing Bits D6/4 L50/12 MP 1FI UC (3x) |
| 500-9857 | HF Routing Bits D6/6 L50/12 MP 1FI UC BAL (3x) |
| 500-9858 | HF Routing Bits D6/6 L58/22 MP 1FI UC BAL (3x) |
| 500-9859 | HF Routing Bit D6/6 L50/14 / POLISHING (1x) |

Complete bit overview of Summa:
www.Summa.com/pdf/summa-router-bits-overview

| | |
|----------|----------------------------|
| 500-0241 | 3 mm Collet for 1050 Kress |
| 500-0242 | 4 mm Collet for 1050 Kress |
| 500-0243 | 6 mm Collet for 1050 Kress |
| 500-0244 | 8 mm Collet for 1050 Kress |
| 500-9379 | 6 mm Collet for HF Router |

Accessories

| | |
|-------------|--------------------------------------|
| 500-9347 | Vacuum Cleaner Bag for Hercules (5x) |
| 500-9348 | Filter for Hercules |
| 500-9349 | Carbon Filter for Hercules |
| 500-9332 | Vacuum Cleaner Bag for 500-9331 (5x) |
| 500-9202 | Remote Controller Pack |
| 1nc40-67034 | Set of 2 Core Holders 3" |

Please contact your dealer for the complete list

F SERIES™



Professional flatbed finishing systems

Summa nv
Rochesterlaan 6
8470 Gistel
Belgium

www.Summa.com

Summa America
100 Cummings Center
Suite #151-G
Beverly MA 01915
USA

Follow us on LinkedIn | Facebook | Twitter | YouTube | #SummaFinish

Copyright 2023© Summa nv. Marketing Communications. Summa nv believes that all illustrations and specifications contained in this catalogue are correct at the time of publication. Summa nv reserves the right to make changes at any time, without notice. RevEN23.02 / All rights reserved

